

DELUGE - RPNX HAZARDOUS LOCATION RUNNING MAN

Class I, div 2, groups A, B, C, D

Class II, div 2, groups F, G

Class III, div 2

The RPNX series of wet location anti vandal running man is designed to operate in extreme environments. The unit, designed using a polycarbonate housing, maintains its sealed interior with a continuous integral gasket. As well, LED pilot light and test switch are sealed type. Available in AC/DC and internally self-powered versions.



FEATURES & SPECIFICATIONS

ELECTRICAL – AC/DC

- LED ultra bright light source
- 120/277/347 VAC 60 Hz Input, field selectable
- 6 V, 12 V and 24 V universal DC
- 6 VDC = 0.8 W, 12 VDC = 0.9 W, 24 VDC = 1.2 W

ELECTRICAL – SELF-POWERED

- LED ultra bright light source
- 120/277/347 VAC Input, field selectable
- High-performance, sealed Ni-Cad battery
- 90 minutes emergency duration (standard)
120 minutes emergency duration is optional
- Solid state transfer and battery charger
- Auto test feature comes standard

MECHANICAL









- Reinforced polycarbonate construction
- Stainless steel tamper proof screws and bits
- One piece, molded and gasketed lens
- Universal spider knock-out pattern stamped into backplate for junction box mounting (backplate available with single face unit only)
- Universal models include ceiling or end mount, field installable canopy kit
- UNVDC Sign: -35°C to +40°C
- Self-Powered Sign: +10°C to +40°C with Cold Weather option added: -20°C to +40°C (available only with BAT)
- Temperature code: T4A

APPROVALS

- CSA Certified to C22.2 #141-15
- CSA Certified to C22.2 #137
- CSA Certified to C860-11
- CSA Certified type 2, 3, 3R, 4, 4X, 5, 12 or 12K
- CSA Certified to NSF 2
- IP66
- IK10
- Class I, div 2, groups A, B, C, D
- Class II, div 2, groups F, G
- Class III, div 2
- According to provisions of the CEC the product may also be suitable for use in Zone 2, Groups IIA, IIB, IIC and/or Zone 22, Groups IIIA, IIIB

COMPLIANCE

- Meets requirements of ICES-005

OVERVIEW	
LIGHT SOURCE	LED
INPUT VOLTAGE [VAC]	120/277/347
DC VOLTAGE / POWER	6 VDC = 0.8 W 12 VDC = 0.9 W 24 VDC = 1.2 W
 LED	 WET LOCATION
 IP RATING	 ICES 005
 HAZARDOUS LOCATION	 IMPACT RESISTANCE
	

For complete warranty details, please see our terms and conditions on our website

TYPICAL SPECIFICATION



TYPICAL SPECIFICATION

Supply and install Aimlite RPNX Series. The RPNX shall be of a reinforced polycarbonate construction, stainless steel tamper proof screws and bits, one piece, molded and gasketed lens, universal spider knockout pattern stamped into back plate for junction box mounting. Universal models include ceiling or end mount, field installable canopy kit. The sign shall operate with AC/DC field selectable 120/277/347 V AC Input, field selectable Emergency DC voltage as follows 6 V 0.9 W, 12 V 0.9 W, 24 V DC 0.9 W. The Self powered configuration shall be AC field selectable 120/277/347v and consist of a long lasting Nickel-Cadmium battery and shall stay illuminated for a minimum of 120 minutes upon AC failure. The self-powered sign comes standard for +10°C to +40°C environments or with a cold weather option for -20°C to +40°C. The face shall be illuminated by using Nichia LED ultra-bright light source. The sign shall come complete with 3 Running Man fibers for universal direction. The Exit Running Man Sign shall be HAZARDOUS LOCATION RUNNING MAN Class I, div 2, groups A, B, C, D Class II, div 2, groups F, G Class III, div 2, CSA 22.2 No.141-15 certified, CSA Certified type 2, 3, 3R, 4, 4X, 5,12 or 12K, CSA Certified to NSF 2, IP66, IK10 and ICES 005 compliant and be Aimlite model number RPNX_____.

ORDERING GUIDE

RPNX					
SERIES	NBR OF FACES	MOUNTING	FRAME COLOUR	DC VOLTAGE (VDC)	OPTIONS
RPNX	1 - SINGLE FACE 2 - DOUBLE FACE	BLANK - UNIVERSAL	BLK - BLACK WHT - WHITE	UNVDC - UNIVERSAL DC BACKUP VOLTAGE FROM 6 TO 24 BAT - SELF-POWERED FOR 90 MINUTES BAT1 - SELF-POWERED FOR 120 MINUTES	ATD ¹ - AUTOMATIC TEST STANDARD CW ² - COLD WEATHER AT -20°C TO +40°C 0 - NO INDICATORS (DOUBLE FACE ONLY) ↓ ↑ ↗ ↘ ↙ ↘ 0 U UR DR DL UL

¹Available only with BAT & BAT1. Mandatory with BAT & BAT1

²Available only with BAT

LEXAN GUARD

	PART NUMBER	DIMENSIONS (IN)
WALL MOUNT	PGD105	20 x 10.25 x 3.5
CEILING MOUNT	PGD100	16 x 10 x 13.5

DIMENSIONS

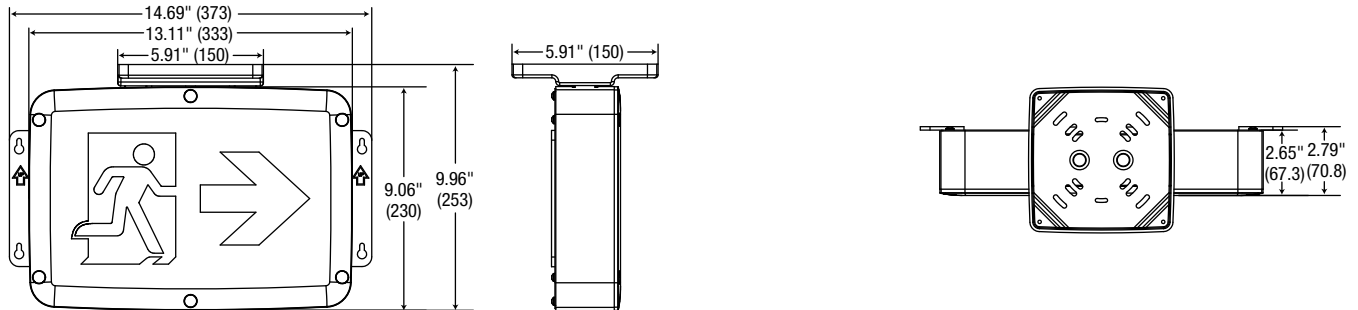

Comes standard (single face) with three pictogram legends for direction selection.



Comes standard (double face) with two pictogram legends.



For double face no arrow options, select "No indicators" on the options column.